



STAMFORD  
SCIENTIFIC  
INTERNATIONAL  
INC.

# Complete AERATION Solutions

FOR THE WASTEWATER INDUSTRY

**AIRFLEX<sup>®</sup>**

Disc Diffusers  
Tube Diffusers  
Retrofits  
Membranes  
Piping & Connectors  
Blowers  
Software

## ABOUT SSI

In June of 2005, SSI celebrated its 10th anniversary. SSI is a privately held company headquartered in Poughkeepsie, New York, USA with operations in the US, the Netherlands, Korea, China and India. We service our customers through a network of agents and distributors in over 70 countries.

We distinguish ourselves in a number of ways, but first and foremost through R & D. SSI has filed for and been granted patents relating to the layering of thin films of VITON™ and PTFE over EPDM, for the first Bayonet type saddle mount for disc diffusers allowing interchangeability of disc diffusers of various sizes on the same piping grid, and to the development of advanced computer software which automates the drafting, spec writing, pricing and calculation functions of diffused aeration system design. We maintain an engineering and 2-D and 3-D capable drafting department and we offer complete design assistance to consultants and customers, including use of our advanced biological simulator which can, for example, effectively predict effluent quality and model the appropriate aerobic and anoxic hydraulic retention times in nutrient removal systems.

SSI has benefited significantly from international business, and as a company policy, we try to localize as much production and investment as possible in those countries which contribute substantially to our growth. We are a member of the Water Environment Federation and we participate in trade shows around the world.



*Dedicated to  
the rapid  
advancement  
of diffuser  
technology*

**Stamford Scientific International, Inc.**

**tel: +1 845 454 8171**

fax: +1 845 454 8094

**[www.StamfordScientific.com](http://www.StamfordScientific.com)**

email: [info@stamfordscientific.com](mailto:info@stamfordscientific.com)

# SSI Materials

## Standard Low Plasticizer EPDM

EPDM is a synthetic rubber which is custom molded for this application. The compound formulation and molding technique are critical to ensure that the membrane maintains its physical properties over a long period of time, resists tearing, retains its shape even after years of continuous or cyclical use, produces fine bubbles, all at a minimal head pressure. Our EPDM membranes are field tested in municipal and industrial applications with excellent results. However standard EPDM is not recommended in cases where solvents, fats oils or greases, or high concentrations of metal salts are present.

## PTFE and VITON™ Layered EPDM

PTFE and Viton™ belong to a category of synthetic elastomers called Fluoroelastomers. They are considered high performance due to their broad spectrum resistance to chemicals, solvents, fats, greases, etc... which can damage conventional elastomers. They are, however, quite expensive. SSI pioneered and patented the use of thin film surface layers of Fluoroelastomers permanently joined to the surface of an EPDM or other substrate base material through patented and now proven methods. The benefit of SSI's advanced technology is that you can have the affordable cost and proven physical properties of a conventional elastomer with the chemical, solvent and fat resistance of the most advanced elastomers in the world. SSI has proven in plants where, for example, calcium deposits and solvent exposure previously caused other materials to fail rapidly, our fluoroelastomer layered membranes are performing without fouling or changes in material properties.

## Silicone and Polyurethane

Prior to SSI's developments related to thin film fluoroelastomers, Silicone and Polyurethane were two candidate materials for plants which had potential problems with membrane failure such as fouling or chemical oxidation of rubber due to solvent exposure. SSI does produce silicone discs and tubes, as well as polyurethane tubes, however we much prefer the characteristics of the fluoroelastomer layered membranes, since both silicone and polyurethane have a tendency over time to suffer from tearing due to flexure failure, which is something that does not significantly afflict EPDM membranes. Neither polyurethane nor silicone is suited to cyclical operation, and neither offers a cost benefit over fluoroelastomer layered EPDM membranes.



## SSI Automated CAD Drafting & Engineering Software

SSI makes the industry's most capable engineering software and this patent-pending application is selectively available through our distributors. Through a simple dialog box, enter your plant's details, and it will produce CAD drawings, perform engineering functions such as line sizing, headloss and heat transfer calculations, write a specification, and calculate complete system pricing.

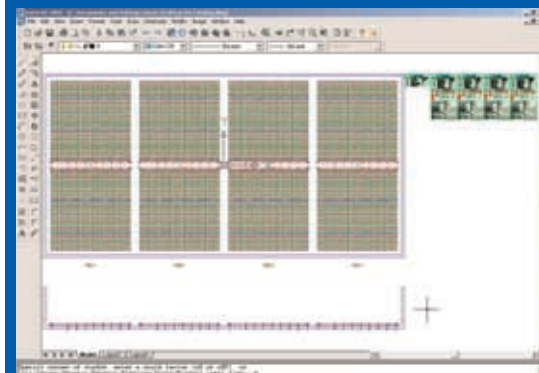

THE STRONGEST MEMBRANES

THE SMALLEST BUBBLES

# AIRFLEX Disc Diffusers



"We confirm that SSI PTFE membranes have been working for six months without clogging problems. Before we had to clean the EPDM membranes every 3-4 weeks!"

Gunnar Larsen, Operator  
Ringkøbing Water Purification Plant  
Denmark

SSI distributors and customers are often invited to witness independently certified oxygen transfer tests.

### 9" Chamber Disc - AFD270-CD

Design Flow: 1.5-3.0 SCFM  
(2.5-5.0 Nm<sup>3</sup>/hr)

Flow Range: 0-7 SCFM  
(0-12 Nm<sup>3</sup>/hr)

Slit Quantity: 6,600

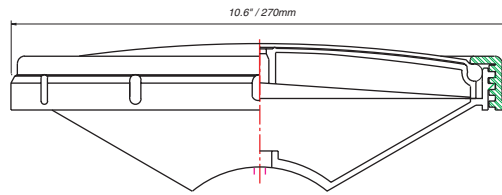

### Standard 9" Disc - AF270

Design Flow: 1.5-3.0 SCFM  
(2.5-5.0 Nm<sup>3</sup>/hr)

Flow Range: 0-7 SCFM  
(0-12 Nm<sup>3</sup>/hr)

Slit Quantity: 6,600

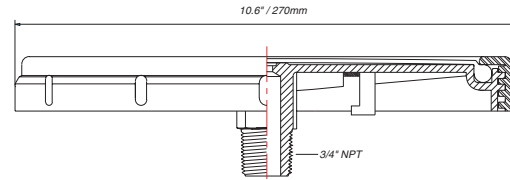

### Standard 12" Disc - AFD350

Design Flow: 2.5-5.0 SCFM  
(4.2-8.3 Nm<sup>3</sup>/hr)

Flow Range: 0-12 SCFM  
(0-20 Nm<sup>3</sup>/hr)

Slit Quantity: 10,155

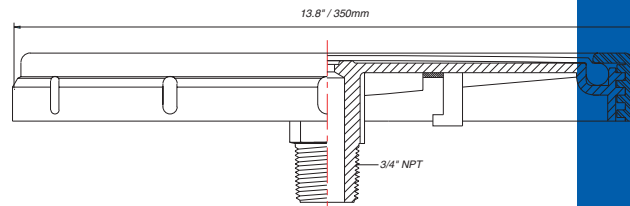

We manufacture our disc diffusers with compression molded membranes. Standard materials are EPDM and fluoroelastomer layered EPDM. Compression molding ensures that we produce a part with even specific gravity and uniform tear resistance. Other molding techniques such as injection molding produce similar looking parts, but the tear resistance of a compression molded part is multidirectional, whereas the tear resistance of an injection molded part tends to be unidirectional just like wood which has a grain.

There is an art to using just the right amount of plasticizer in an EPDM membrane. Use too much, or the wrong type, and emulsifying fats can leech plasticizer and cause shrinkage and increase hardness. Use too little, and the rubber loses its memory, bubble size increases, and the membrane is at risk for flexure failure. SSI has had a great deal of experience experimenting with different types and amounts of plasticizer, as well as other components of formulated EPDM rubber, such as fillers and curatives, and we put this experience to work.

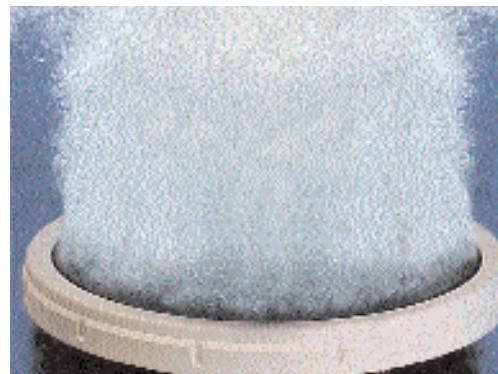

Membrane perforation and surface charge are additional considerations. SSI perforates disc membranes from the inside out with specially shaped knives. This results in the smallest part of the perforation on the membrane surface where the bubble is released. Through proprietary compounding and surface treatments, we are able to create a smooth perforation on a hydrophilic surface which quickly releases small bubbles, typically from 1 to 2 mm in diameter.

SSI uses environmentally friendly materials whenever possible. Our disc diffuser parts are predominantly made of polypropylene, which offers the added benefit of high temperature resistance to 212 F (100C)

SSI disc diffusers connect to pipe with Quick Connect Saddles, Grommets, or by solvent welding to the crown of PVC headers. Our factory pre-assembled discs install onto Quick Connect Saddles with just 1/4 turn, and these saddles allow flexibility to upgrade from 9" to 12" discs

#### Grommet Mount

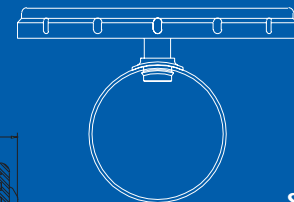

#### Saddle Mount

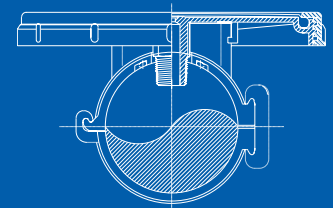

## SANTAIRE™ Retrofit Diffuser



THE STRONGEST MEMBRANES  
ECONOMICAL TO INSTALL

# AIRFLEX Tube Diffusers

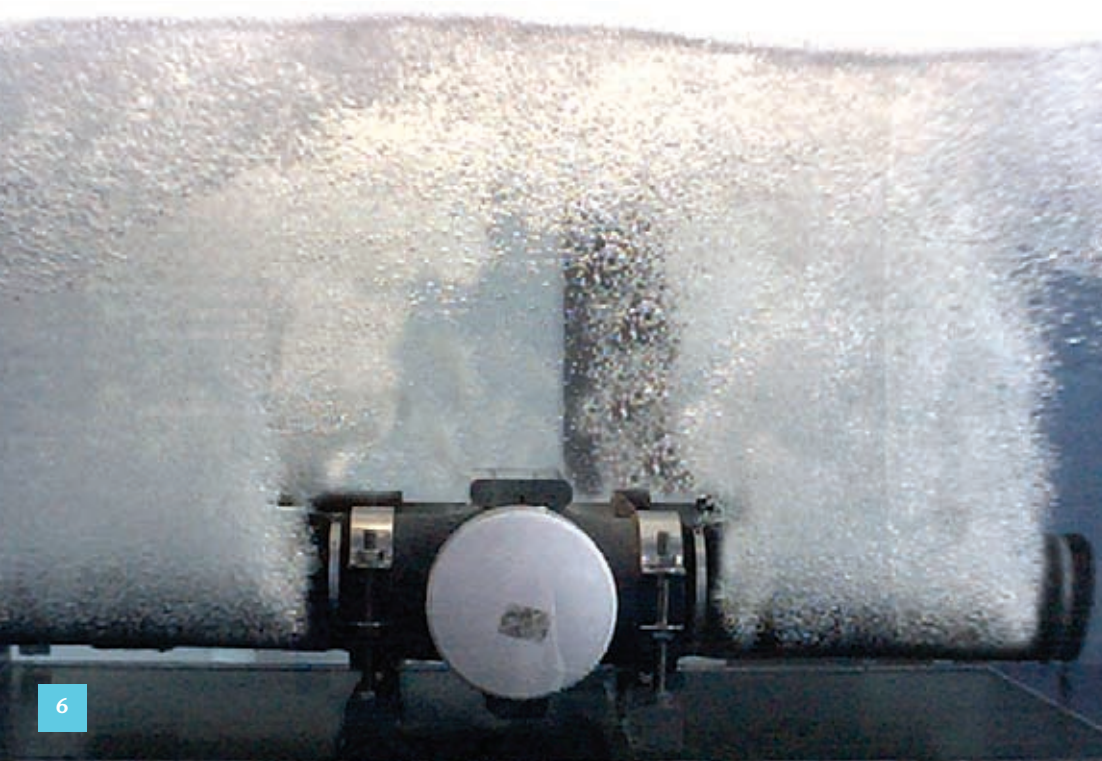
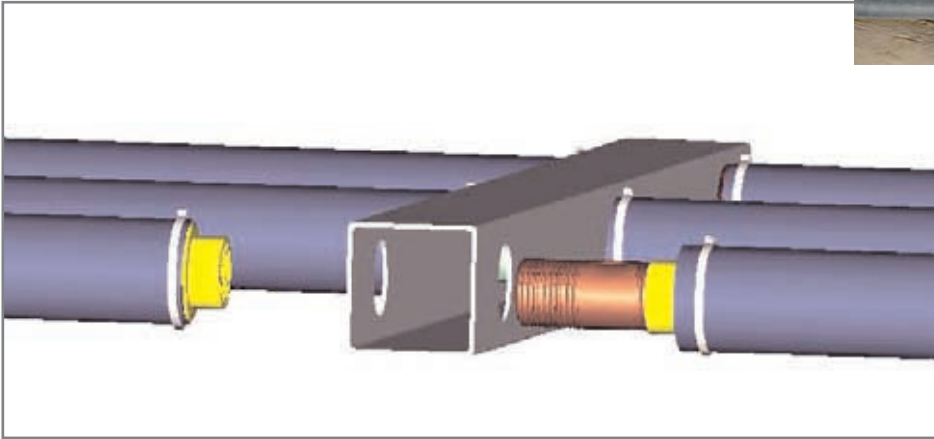
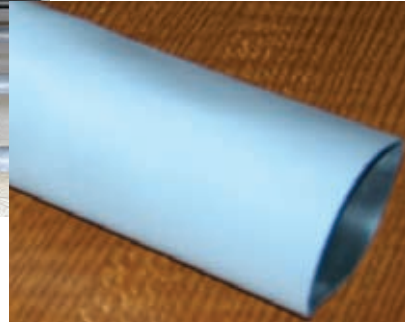
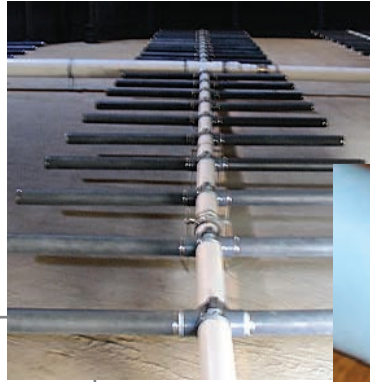

SSI offers three methods of connection to pipe – With our Super Saddle or Stainless Nipple for Round Pipe, or with a Double Stainless Nipple and Gaskets for Square Pipe.

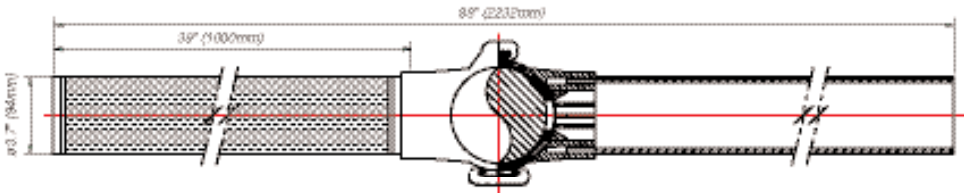

**Airflex Tube 1000 (AFT1000 with Super Saddle)**  
**3.7" Ø (94mm) x length up to 39" per side (1000 mm)**  
**Design flow: 3 SCFM per foot of length (16 Nm<sup>3</sup>/hr per meter)**  
**Flow range: 0-9 SCFM per foot of length (0-50 Nm<sup>3</sup>/hr per meter)**

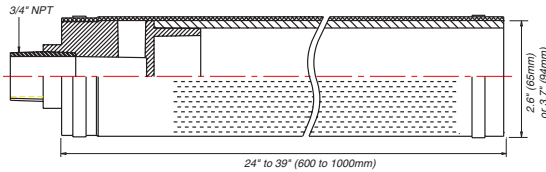

**Airflex Tube**  
**2.6" Ø (65mm) or 3.7" Ø (94mm) x length up to 39" (1000 mm)**  
**Design flow 2.6": 2 SCFM per foot of length (11 Nm<sup>3</sup>/hr per meter)**  
**Range 0-5 SCFM/ft (0-28 Nm<sup>3</sup>.hr/m)**  
**Design flow 3.7": 3 SCFM per foot of length (16 Nm<sup>3</sup>/hr per meter)**  
**Range 0-9 SCFM/ft (0-50 Nm<sup>3</sup>/hr/m)**

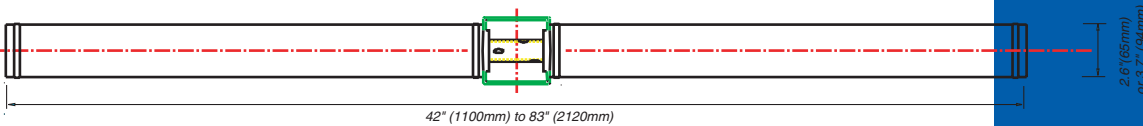

**Airflex Tube for Square Pipe**  
**2.6" Ø (65mm) or 3.7" Ø (94mm) x length up to 83" (2120mm) per set.**  
**Design flow 2.6" (65mm): 2 SCFM per ft. of length (11 m<sup>3</sup>/hr per meter)**  
**Range: 0-5 SCFM per ft (0-28 m<sup>3</sup>/hr/m)**  
**Design flow 3.7" (94mm): 3 SCFM per ft. of length (16 m<sup>3</sup>/hr per meter)**  
**Range: 0-9 SCFM per ft (0-50 m<sup>3</sup>/hr/m)**



## Discs & Tubes

### MATERIAL PROPERTY SPECIFICATIONS

SPECIFICATIONS	PP DISC BASE & RETAINING RING	EPDM MEMBRANE	PTFE ON EPDM MEMBRANE
Coefficient of thermal expansion, in/in/deg. F x 10 <sup>-5</sup> (ASTM-969)	5	—	—
Maximum operating temperature, deg. C	100	—	—
Tensile strength, psi @ 73F (ASTM D638)	5000	—	—
Tensile strength, psi (ASTM D412-92)	—	2000	2000
Tear strength, Die T, pli (ASTM D624-91)	—	110	110
Resistance to thermal deterioration, 70 hours @ 70°C, (ASTM D573-88)			
a. Change of tensile strength, %	—	<3	<3
b. Change of elongation, %	—	<25	<25
c. Change of hardness, shore A reading	—	<5	<5
Ozone resistance, 70 hours, 40°C, 50mPa partial ozone pressure, non cracking (ASTM D1171-94)	—	pass	pass
Extractable oil content	—	10%	10%
Resistance to Chemicals	Excellent	Good	Excellent
Resistance to Fat, Oil & Grease	Excellent	Poor	Excellent
Resistance to Solvent	Excellent	Poor	Excellent
Resistance to Ageing	Excellent	Very Good	Excellent
Resistance to Fouling (i.e. Biofouling, Calcium deposit)	Excellent	Fair	Excellent

Airflex Tubes are available with Super Saddle, Single or Double Nipple connections, in a variety of lengths and diameters. Our tubes are designed for maximum strength at a minimum positive buoyancy. Although tubes are generally not as efficient as discs, they are often the most economical choice of all diffusers, particularly the 3.7" diameter x 39" type (94mm x 1000mm) because of their relatively large size & high air capacity compared to disc diffusers. They require fewer header pipes, less support stands, and less installation time than disc diffusers. If you are designing a fine bubble aeration system on a tight budget, a tube aeration system may be for you.

Our Airflex Super Saddle mounts tightly on 4" Sch 40 PVC pipe or Sch 10 stainless pipe with a 4.5" (114.3mm) or 110mm Outside Diameter. Threaded nipple type diffusers can connect both 2.6" (65mm) and 3.7"(94mm) diameter tube diffusers to square or round pipe.

Tube membranes are extruded from low extractable oil content EPDM, silicone, silicone blend, urethane, and neoprene blend. PTFE and Viton™ layered EPDM tube membranes are also available. Perforations are offered in 1mm and 2mm slit lengths, and both saddles and nipples are designed to mount to US or Metric dimension pipes.

# AIRFLEX Accessories & Blowers

## Grommets

Grommets are available for round plastic or square stainless pipes in US or Metric dimensions. Simple installation.



## Saddles

Patented Quick Connect Saddles mount on nominal US 4" or metric 110mm OD pipe. They allow retrofit of 12" to 9" discs without changing the piping system, and it is possible to change the membrane without removing the diffuser from the saddle.



## Expansion Joint Options

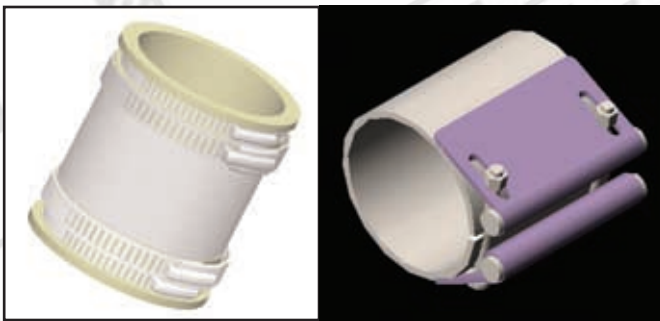

Fernco™

Straub™-type coupling

## Pressure Monitoring Systems and Purge Systems



## Coarse Bubble Diffusers

SSI manufactures Airflex Band stainless steel wide band and Airflex Cap plastic coarse bubble diffusers, both with 3/4" MNPT connections. 24" (610mm) Airflex Bands typically handle from 10 to 40 SCFM (17 to 68 m3/hr), and Airflex Caps are designed at 5 SCFM (9 m3/hr).

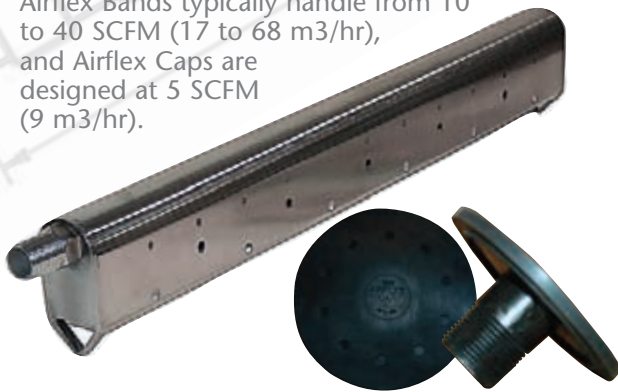

## Support Stands Stainless Steel and Plastic



## Blowers

Pictured are "Roots" type, multistage centrifugal, and side channel blowers. Blowers are available bare shaft or packaged with motor, accessories, and sound enclosures, and can be sized for 50 or 60 Hz.

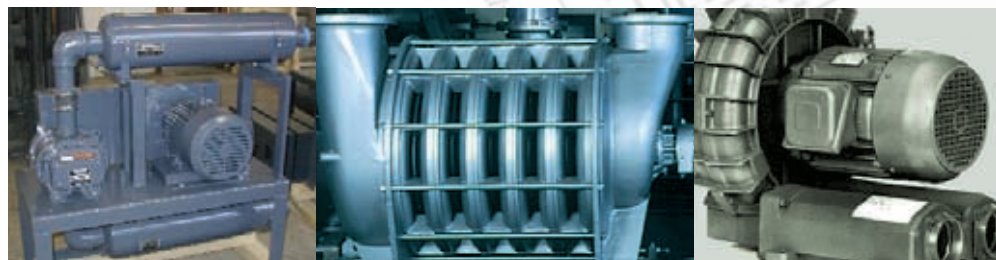



# Membranes & Parts For Your Brand

SSI is the leading aftermarket manufacturer of replacement membranes for other brands of diffuser. Membranes are produced with the same high quality materials used to produce our own products and our patent-pending PTFE or Viton™ layered EPDM is available as an option.

## Sanitaire™, Aercor™ & EDI™

SSI manufactures 9" disc membranes which retrofit original PVC diffuser holders. We also make backer plates which together with our membrane can convert an existing ceramic disc installation to SSI membrane. A low pressure drop version is available.

## Nopon™

SSI manufactures disc retrofit membranes for both 215 and 300 sized diffusers.

## Roediger™, Envicon™

SSI manufactures disc retrofit membranes for both companies nominal 12" disc diffusers.

## All Tube Diffusers

SSI manufactures replacement tube membranes for all brands of tube diffuser from 1" (25mm) through 4.6" diameter (117mm). Tube membranes are available with 1 or 2mm slits.

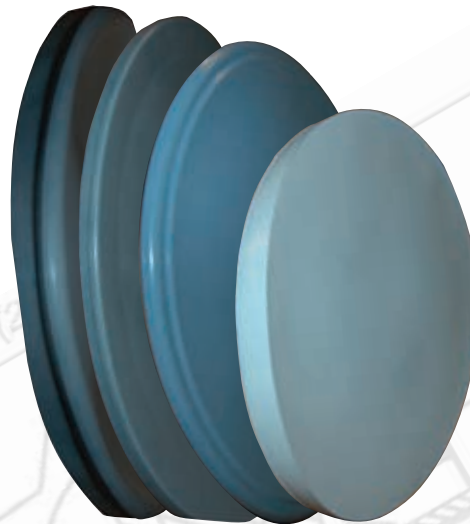

From left to right: Envicon™, Roediger™, Nopon 300™ and Nopon 215™ disc membranes.

The following graph depicts performance of two tanks in Denmark. Tank 1 has Nopon™ 300 size diffusers. In Tank 2, SSI replaced the Nopon™ membranes with SSI 12" retrofit membranes. The two tanks ran side by side.

Notice how the valve to the air supply in the SSI tank is mostly closed, and the valve to the air supply in the Nopon™ tank is mostly open, yet the Dissolved Oxygen is higher in the SSI tank, in spite of receiving much less air.

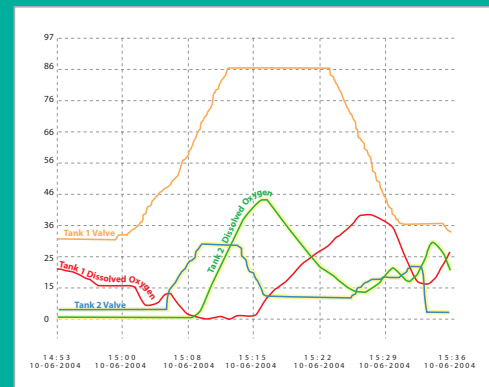

## Retrofit Kit

SSI offers a retrofit kit to convert existing 9" Sanitaire™ membrane and ceramic installations to SSI 12" discs. Increase your plants efficiency or your air capacity and add a PTFE layer to bring your aeration system into the modern age.

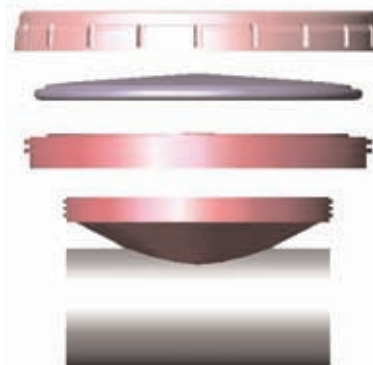

\*Sanitaire™, Aercor™, EDI™, Fernco™, Nopon™, Roediger™, Straub™, and Envicon™ are not affiliated in any way with SSI, and SSI does not make original name brand parts for any of these independent companies.

# SSI Experience

SSI designs and manufactures fixed grid and retrievable systems using proven components which have been field tested for over 10 years. All parts of our aeration systems are corrosion resistant, leak resistant, and UV resistant. We have empirical data on field performance, as well as the experience to know when to apply which diffuser, which piping material, and how to design fixed grid and retrievable systems successfully. We can deal with irregular concrete floors, with earthen lined lagoons, and with dry or wet-install retrievable systems.

There is limited field assembly work required with our systems, and never any field welding required. SSI saddles and grommets come factory mounted, and SSI diffusers come completely assembled ready to mount.



Disc diffusers in operation.



Tube diffusers in operation

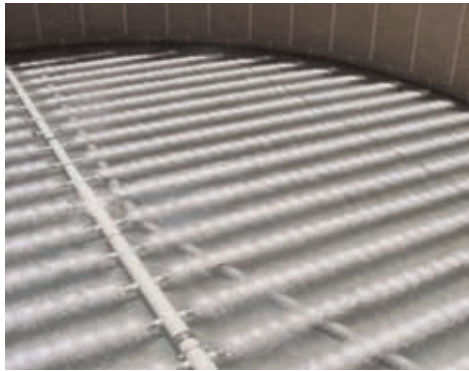

## Testing

SSI regularly tests its products both in-house and independently. We have conducted a number of independent oxygen transfer tests per ASCE absorption, as well as off-gas tests. In-process tests have been carried out on our equipment in oxidation ditches and SBR's as well. We offer startup and commissioning services, and we can arrange oxygen transfer tests as needed.

If you are unsure of your plant's alpha factor, we can also assist you to predetermine alpha in order to properly design your plant's aeration system.





## AERATION DESIGNED FOR:

# Conventional, SBR, MBR, & Nitrifying Systems

SSI has installations of tube and disc diffusers and complete aeration systems in North and South America, Europe, Asia, the Middle East, and Africa. Consulting engineers such as CH2M Hill™, CDM™, O'Brien and Gere™, Stantec™, and Earth Tech™ have used our systems. Fortune 500 companies such as Coca-Cola™, Pepsi-Cola™, Nestle™, Kraft™, Conoco Philips Petroleum™, Sonoco™, Reynolds Aluminum™, International Paper™, and Repsol™, are also among SSI's customers. A few sample installations include:

**Plant Name:** West Lafayette WWTP  
**Location:** West Lafayette, Indiana USA  
**Type:** SBR  
**Diffuser Qty:** 3,000 pcs Airflex Disc (EPDM membrane)

**Plant Name:** Grand Forks WWTP  
**Location:** Grand Forks, North Dakota USA  
**Type:** BNR Plant  
**Diffuser Qty:** 2,050 pcs Airflex Disc (EPDM membrane)

**Plant Name:** Kwangju WWTP  
**Location:** Kwangju, Korea  
**Type:** Conventional Activated Sludge  
**Diffuser Qty:** 28,700 pcs Airflex Disc (EPDM membrane)

**Plant Name:** Coca Cola  
**Locations:** Philippines, Vietnam and Malaysia  
**Type:** SBR & Conventional Activated Sludge  
**Diffuser Qty:** 7,300 pcs Airflex Disc (EPDM membrane)

**Plant Name:** Huntsville WWTP  
**Location:** Huntsville, Alabama  
**Type:** Conventional Activated Sludge  
**Diffuser Qty:** 13,000 pcs Tube Membrane (Polyurethane Membrane)

**Plant Name:** Nancun WWTP  
**Location:** Nancun, China  
**Type:** SBR  
**Diffuser Qty:** 1,440 pcs Airflex Tube 1000 (EPDM Membrane)

**Plant Name:** Brasilia WWTP  
**Location:** Brasilia, Brazil  
**Type:** BNR Oxidation Ditch  
**Diffuser Qty:** 6,600 pcs Airflex Disc (EPDM Membrane)

**Plant Name:** Acqui Terme WWTP  
**Location:** Torino, Italy  
**Type:** Conventional Activated Sludge  
**Diffuser Qty:** 2,000 pcs Airflex Disc (EPDM Membrane)

**Plant Name:** Al-Mukaramah STP  
**Location:** Makkah, Saudi Arabia  
**Type:** A2O Ditch Process  
**Diffuser Qty:** 45,000 pcs Airflex Disc

**Plant Name:** Agropur Co-operative  
**Location:** Quebec, Canada  
**Type:** Dairy WWTP  
**Diffuser Qty:** 1000 pcs Airflex Disc with PTFE layer

**Plant Name:** Aylesbury STW/ Thames Water  
**Location:** Aylesbury, UK  
**Type:** Conventional Activated Sludge  
**Diffuser Qty:** 3500 pcs Airflex Disc

**Plant Name:** Songnam STP  
**Location:** Songnam City, Korea  
**Type:** Conventional Activated Sludge  
**Diffuser Qty:** 2350 sets Airflex Tube 1000 with PTFE layer



## CLIENT Feedback

“In 2003 our company El Concorde Construction Ltd purchased approx. 6000 sets of AFT1000 diffuser from SSI. I evaluated a number of European and American companies who offered similar product, and finally selected SSI due to the robust product and good communication. The total capacity is 80 million gallons and the diffusers are performing very well and according to expectations.”

Ghassan Al Ayyubi  
 P. Technical Advisor  
 El Concorde Construction Ltd, Jordan

“We installed over a thousand SSI 9" fine bubble disc diffusers in 1997 and are still operating with the original membranes in 2005. Since installing the diffusers, the plant has met its effluent requirements and we are thoroughly satisfied with the aeration system applied by SSI. The Ford Road WWTP serves a population of 13,000 and is rated for 3.6 MGD.”

Jason Tincu  
 Wastewater Supervisor  
 City of Xenia, Ohio

“We have sold Airflex diffusers to plant manufacturers and plant owners. (Complete) Systems were built with know-how from SSI that supported us in the projects, calculations and choice of materials. Results of applications are excellent. We have gotten savings in energy costs up to 50% when compared with previous diffuser systems.”

Dr. Gianfranco Ramazzotti  
 Tecneco Service S.a.s.  
 Torino, Italy

“Nine suppliers' membrane diffusers were evaluated. The 12" SSI Airflex diffuser provided the performance we desired plus the lowest, long-term, life cycle ownership costs of any diffuser investigated. Approximately 2050 SSI diffusers were installed in this BNR-capable facility.

SSI has been a pleasure to work with...their service was exemplary.”

Cal Tininenko, Chief Scientist  
 Bac Tee Systems, Inc.  
 Grand Forks, ND USA

“All these SBR plants are 6 to 8 meters deep and we had no mechanical problems whatsoever with the SSI fine bubble diffusers. The system seems to have delivered the expected performance as we had no problems in meeting the treatment performance. We have also successfully replaced the Sanitaire™ membranes on two projects in Quebec, Canada.”

Gaetan Desjardins, President  
 Eco Process & Equipment Int'l Inc.  
 Montreal, Canada

“Our SSI designed aeration system works very well, and continues to save money on energy costs. To this date we have not needed to replace any membranes, nor has there been any other maintenance required on the SSI aeration system. I would highly recommend SSI.”

Scott L. Lods, President  
 American Suburban Utilities, Inc.  
 West Lafayette, IN USA

# SSI Performance Testing

## MEMBRANE PERFORATIONS

TYPICAL SIZE ADD'L SIZES AVAILABLE	PERFORATED DIMENSION	APPROX. SLIT QUANTITY(1MM)
9" disc AFD270	8.3"/210mm Ø	6,600
12" disc AFD350	11.1"/ 282mm Ø	10,500
62 x 610	22.0"/560mm L	18,000
62 x 1003	37.0"/950mm L	30,000
78 x 762	28.0"/710mm L	30,000
92 x 1003	37.0"/950mm L	45,000

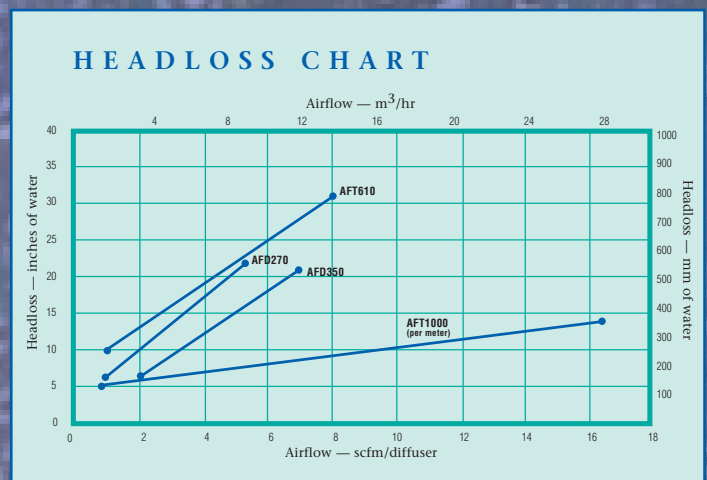
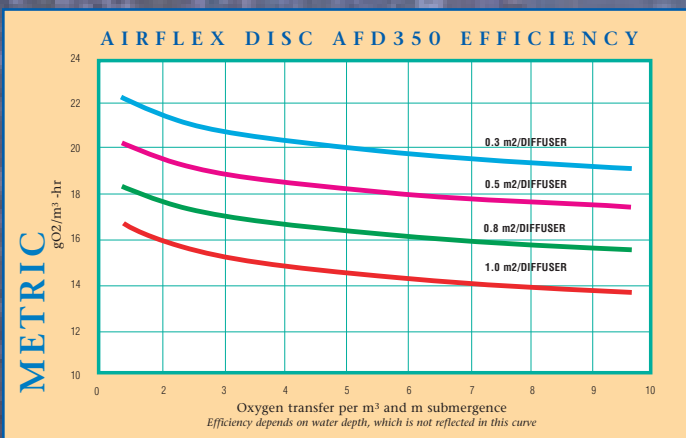
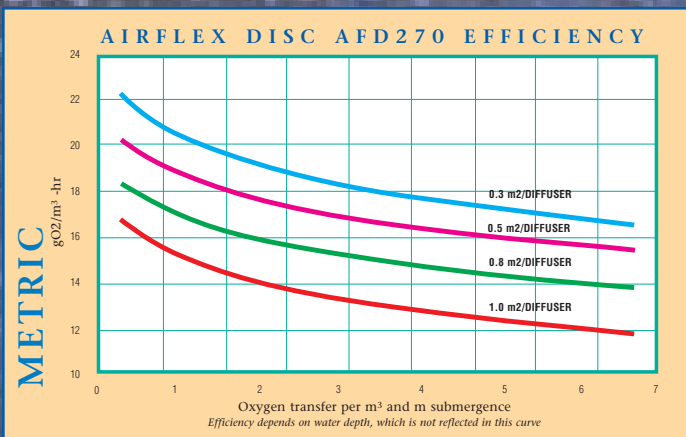
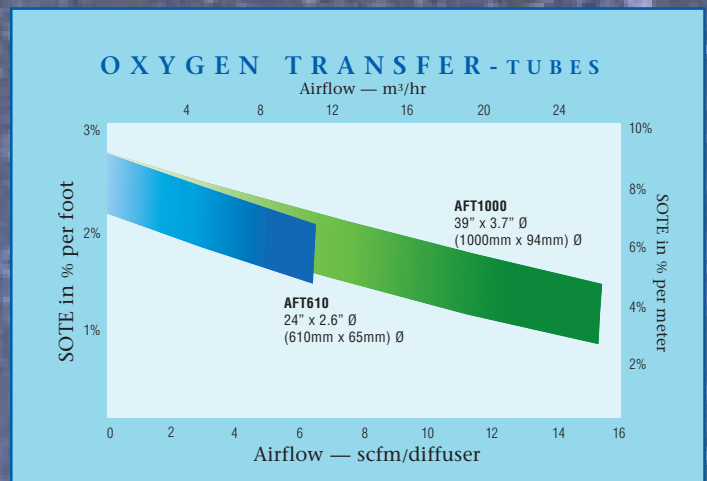
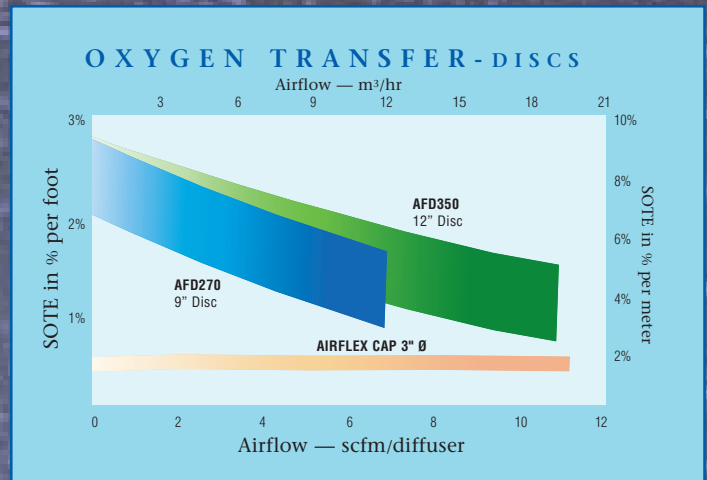

## SSI Warranty

SSI aeration products and systems are warranted to be free from defects in manufacture or workmanship for 12 months from the date of installation, up to 18 months after the date of shipment. Parts found to be defective in materials or workmanship will be repaired

or replaced without charge, with freight to be at our option. The responsibility of SSI is limited to the cost of defective parts. Damage caused to SSI aeration products by chemicals, wear caused by the presence of abrasive, sticky or oily materials, poor maintenance, installation or operation not in accordance with our manual shall not constitute defects. SSI is able to stand behind our pledge of quality because we continually test all our equipment ensuring greater quality control. Our test results are made available upon request.

SSI maintains production and support facilities in various locations USA (New York – Headquarters, Manufacturing, Engineering and Customer Service), Europe (Holland – Warehouse, and Hungary - Manufacturing), and Asia (Korea – Manufacturing and Engineering, China - Manufacturing and India - Engineering).

SSI manufactures aeration systems, not complete wastewater treatment plants, thus we are not responsible for final plant effluent quality.



STAMFORD  
SCIENTIFIC  
INTERNATIONAL  
INC.

845-454-8171

fax: 845-454-8094

[www.StamfordScientific.com](http://www.StamfordScientific.com)

email: [info@stamfordscientific.com](mailto:info@stamfordscientific.com)